











INCLUDED
2 MOUNTING
SOLUTIONS IN 1 BOX



FPMA-D550DBLACK

-  **10-32"**
25-81 cm
-  **8kg**
17.6 lbs
(each screen)
-  **MIN: 75X75**
MAX: 100X100
-  **180°**
-  **+45° | -45°**
-  **360°**
-  **0-44 cm**
-  **GROMMET**
CLAMP
-  **EAN**
8717371446284

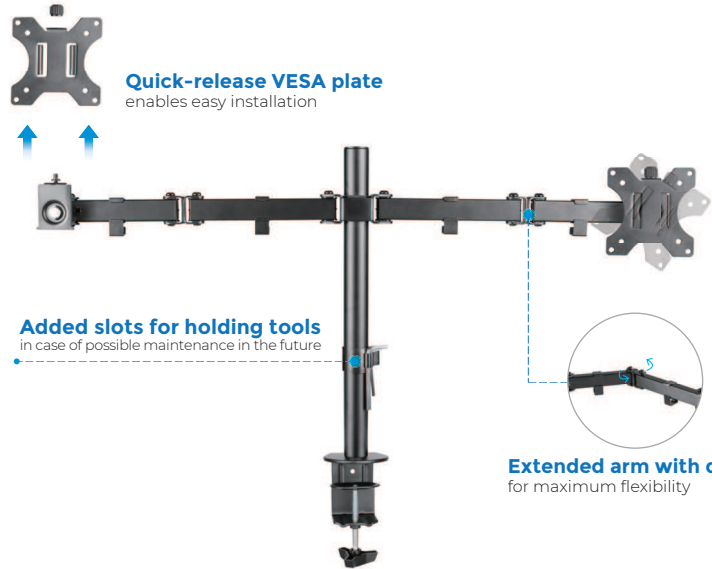
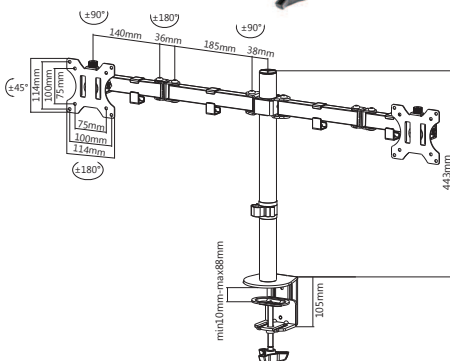

Quick-release VESA plate
enables easy installation

Added slots for holding tools
in case of possible maintenance in the future

Extended arm with double joint
for maximum flexibility

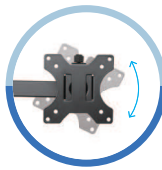

Rotatable VESA plate
Easily turn your screen from landscape to portrait mode.

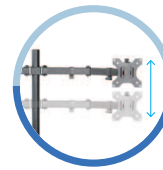

Height adjustable arm
For an optimal ergonomic position.

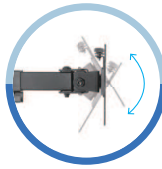

Free tilt mechanism
Allows the mount to change to any viewing angle.



Cable clips included
Keeps cables organized and protected.