

CTP25

Introduction

The CTP25, a cutting-edge touch console specifically designed for meeting control. With its user-centered interactive design and a 10.1-inch touchscreen, users can effortlessly join and manage meetings with ease. Say goodbye to the complexities of video conferencing as CTP25 simplifies the process, delivering an enhanced meeting experience. It seamlessly integrates essential meeting functions, including direct connection to the system, screen sharing, BYOD, and PD charging capabilities. Elevating communication efficiency to new heights.



Key features and benefits

- 10.1 inches, and ultra-high screen-to-body ratio
- Support Android 13 (continue to update)
- MDEP Supported (in September)
- USB-C wired content sharing/BYOD/power
- Ultrasonic technology
- Multiple deployment methods

Immersive HD Display, Stable Touch

Experience immersive visual excellence with the CTP25. Boasting a 10.1-inch size and a high screen-to-body ratio,

this device provides a captivating visual experience. Its IPS panel showcases crystal-clear images, ensuring vibrant and sharp visuals. The IPS hard screen's unique horizontal molecular structure brings exceptional stability, eliminating water ripples, shadows, and flickering when touched. Enjoy seamless touch interactions on the CTP25, where stability and responsiveness combine for an unparalleled user experience.

Experience Secure MDEP with Android 13

Experience the Latest and Most Secure User Experience with the CTP25. The CTP25 is powered by Android 13 and provides continuous updates, ensuring customers always enjoy the newest features and enhanced security. With compatibility with MDEP (Microsoft Device Ecosystem Platform), the CTP25 provides a more secure environment and streamlined deployment processes. Stay ahead of the curve with the latest updates while enjoying peace of mind knowing your device is protected.

Flexible Deployment, Powerful USB-C

Enhance your collaboration with the seamless integration of Yealink CTP25 and MeetingBar A40. Simply connect the CTP25 to the MeetingBar A40 using an ethernet cable, and enjoy a simplified Teams Room login process. With the option to log in to your Teams account once on either device, deployment becomes effortless, saving time and enhancing convenience. The USB-C cable of CTP25 supports 4K content sharing, wired BYOD (Bring Your Own Device), and provides up to 45w PD2.0 for laptop charging. By replacing the adapter, you can achieve a maximum power output of 60w, catering to higher charging needs. This all-in-one cable solution meets the diverse needs of users in conference rooms, ensuring a streamlined and efficient collaboration experience.

Specifications

Specifications	Description
OS	<ul style="list-style-type: none"> Android 13.0
Display	<ul style="list-style-type: none"> Screen: 10.1 inch Display Type: IPS Resolution: 1280 x 800 Contrast ratio: 1000:1 Brightness: 350 cd/m² (typical) Viewing angle (horizontal/vertical): 178°(H)/178°(V) Touchpoints: Multi-points capacitive touch support Anti-glare Anti-fingerprint
Audio	<ul style="list-style-type: none"> Built-in Ultrasound Unit
Wireless	<ul style="list-style-type: none"> Wi-Fi 6 802.11a/b/g/n/ac/ax Bluetooth 5.0
Network	<ul style="list-style-type: none"> VLAN, 802.1P/Q, and Diffserv 802.1X, and LLDP-MED HTTPS
Device Management	<ul style="list-style-type: none"> Yealink Web Portal Yealink Device Management Platform Teams Admin Center Zoom Device Management

Physical Interface	<ul style="list-style-type: none"> · 1 x USB-A port · 2 x USB-C port · 1 x RJ45 port (PoE 802.3af compaint) · 1 x Reset hole · Motion Sensor
Installation	<ul style="list-style-type: none"> · Place on the Table · Mount on the Table · Mount on the Wall
Package	<ul style="list-style-type: none"> · CTP25 · 7.5m Ethernet Cable · 1.2m USB-C Cable · PD Power Adapter (65W) · Screwdriver · High Stand · Cable Management Cover · M3 Screws * 10 · Cable Ties * 5 · Quick Start Guide
Mounting Bracket	<ul style="list-style-type: none"> · Standard: High Stand · Optional: <ul style="list-style-type: none"> - Rotatable desktop mount with rotation angle: 90° left and right. - Wall mount
Environment	<ul style="list-style-type: none"> · Operating Temperature: -10 to +45°C · Storage Temperature: -30 to +70°C
Power	<ul style="list-style-type: none"> · Power Consumption: <ul style="list-style-type: none"> - Standby: 5 W - Average: 7.3 W - Peak: 15.2 W · Power Adapter: 65W PD · PoE: IEEE 802.3af and above
Dimensions &Weight	<ul style="list-style-type: none"> · Box: <ul style="list-style-type: none"> - Dimension: 286 × 198 × 140 mm - N.W/CTN: 1.578 kg - G.W/CTN: 1.846 kg · Canton: <ul style="list-style-type: none"> - Dimension: 725 × 410 × 300 mm - N.W/CTN: 18.478 kg - G.W/CTN: 19.798 kg - Quantity: 10 pieces · CTP25: <ul style="list-style-type: none"> - Dimension: 242.95 × 27.50 × 161.95 mm - Weight: 0.683 kg

Device Compatibility

The maximum number of CTP25 supported by the conferencing room endpoint is as follows:

Device Name	Max. number of CTP25 supported
MeetingBar A10、 MeetingBar A20、 MeetingBar A30	×
MeetingBar A40	1
MeetingBoard 65、 MeetingBoard 86、 MeetingBoard 75 Pro	×
DeskVision A24	×
MeetingEye 500、 MeetingEye 500 Pro, MeetingEye 900	1

Hardware Introduction

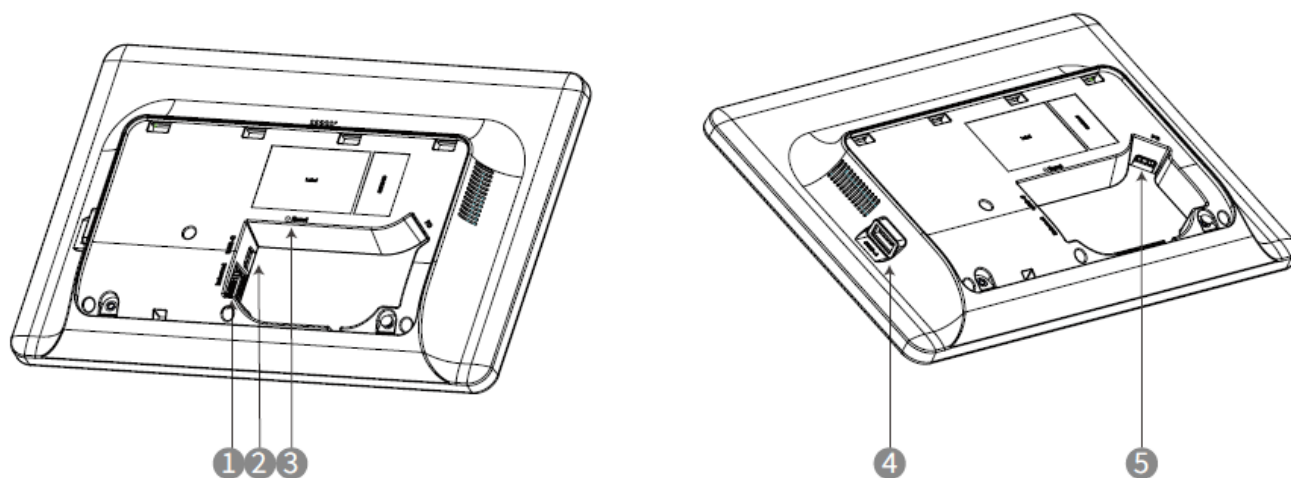

Number	Hardware Interface	Description
1	Internet	Connect to an endpoint, network, or PoE switch that meets the specifications of 802.3af and above.
2	USB-C	Connect to a PC for content sharing. When connected to a PD power adapter, CTP25 can power the PC.
3	Reset	Reset the CTP25 to factory defaults.
4	USB-A	Reserved interface.
5	PD	Connect to a PD power adapter.

Installation

Place on the Table

- 1 Screw specifications:
M3 screw

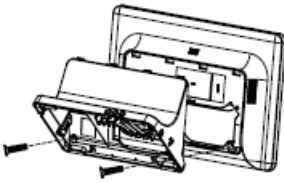

- 2 Recommended cable management method:

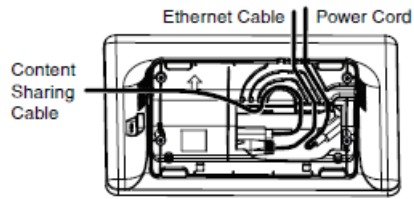

- 3 Screw specifications:
M3 screw

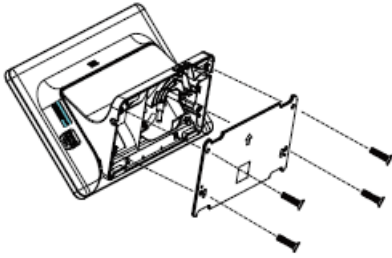

Mount on the Table

- 1 Screw specifications:
M3 screw

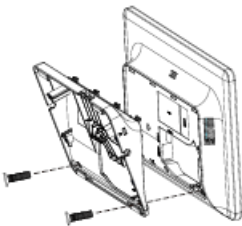

- 2 Recommended cable management method:

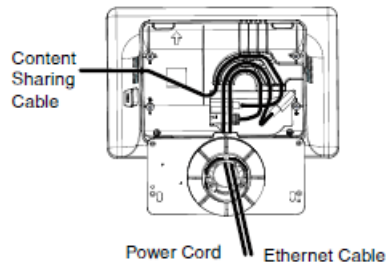

- 3 Screw specifications:
M3 screw

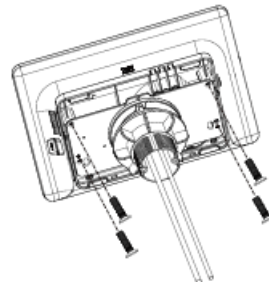

- 4 Make sure the two arrows on the table mount are aligned.

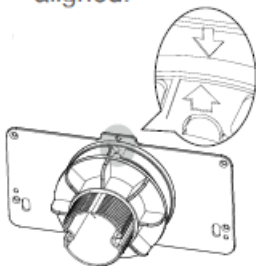

- 5

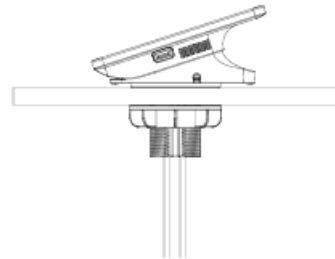
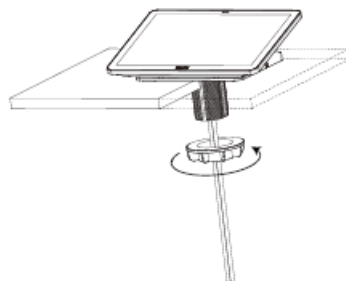

Mount on the Wall

NOTE

- We recommend that the height of the wall-mounted is 1m~1.5m from the ground.
- If the conference room environment allows, you can also wire through the wall.

1 Screw specifications:
Φ6 * 30 mm, Expansion bolt

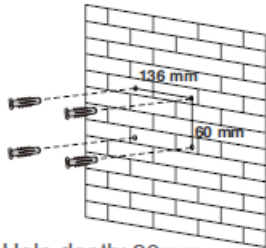

Hole depth: 30mm
Hole diameter: 6mm

2 Screw specifications:
T4x30, Self-tapping screws

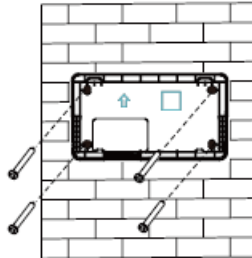

3 Screw specifications:
M3 Screw

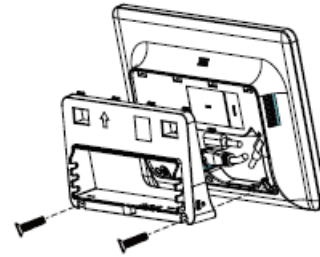

4 (Surface-mounted conduit)
Recommended cable management method:

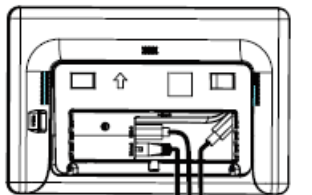

Ethernet Cable Power Cord
Content Sharing Cable

(Pattress)
Recommended cable management method:

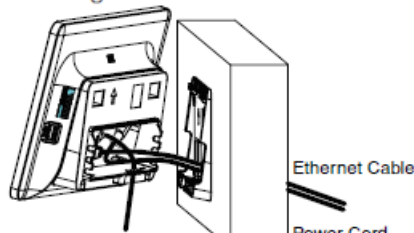

Content Sharing Cable

5

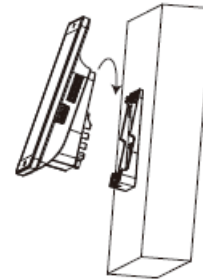

6 Screw specifications:
M3 screw

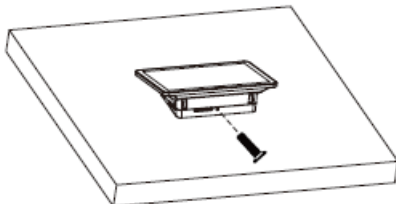

Connection

NOTE

- PC: Equipped with an HDMI or USB-C (support DP protocol) Port.
- The feature differences using USB-C or USB-C to HDMI cable are as below:

	Content Sharing	BYOD	PD Charging
USB-C	√	√	√
USB-C to HDMI	√	×	×

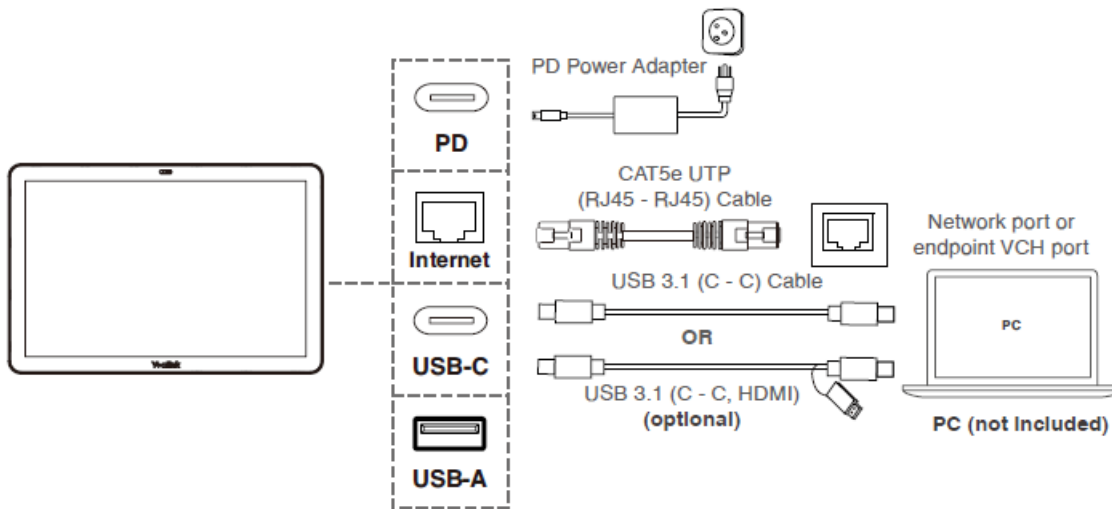

The usage of CTP25 with different conferencing endpoints is different. Please refer to the corresponding document to know more about the connection, pairing and update of CTP25 with the different conferencing endpoints.

How to Use

The usage of CTP25 with different conferencing endpoints is different. Please refer to the corresponding document to know more about the connection, pairing and update of CTP25 with the different conferencing endpoints.

Teams Version:

- Connect the CTP25 to MeetingBar: [CTP25 Touch Panel](#)

Zoom Version:

- Connect the CTP25 to MeetingBar: [CTP25 Touch Panel](#)
- Connect the CTP25 to MeetingEye: [CTP25 Touch Panel](#)